

A.Y. McDonald

CONNECTION



Volume 4, No. 7 | Fall / Winter 2020



Connecting with and Caring for the Boss in the Year 2020

by Scott Knapp

In 2016, the A.Y. McDonald Connection newsletter was launched and I wrote about staying connected in the digital world. What I find ironic is that if we've learned anything from 2020, it's that nothing replaces an in-person connection. Phone calls and even video conferencing will never replace locking eyes and shaking hands, at least for me. Getting 'back there', however, looks to be a slow process. Navigating those waters is also tricky business and very personal.

As most readers of this newsletter work in industries that are deemed essential – providing water and natural gas for infrastructure – we've all dealt with how to move forward in real-time. This requires doing business and offering services while also being respectful of our co-workers and customers' personal space. This work is not easy and requires a deeper level of caring and understanding than usual. One of the most fulfilling parts of working in the industries we serve is that they are filled with good, fun, and interesting people. Maintaining those real connections is part of what makes A.Y. McDonald unique. As the business world continues to become more impersonal, we do just the opposite, and we always have.

2020 has required all of us to adapt – to remain flexible, patient, and forgiving. Regardless of how we connect today, know that A.Y. McDonald's ability to care hasn't changed. Our co-workers are still grateful for the opportunity to take care of you, our boss. While opportunities for locking eyes and shaking hands are fewer, they are not lost. People and connections are precious. We will keep them by whatever means necessary and look forward to when 'in-person' goes back to being the 'new normal.'



AYU – Knowledge at Your Fingertips

You know all those questions you had when you first entered the industry, and even decades into the job? Well, A.Y. McDonald is here to finally answer them with the help of A.Y. McDonald University (AYU). By writing down and organizing product knowledge from our own products experts, you can learn the benefits of press fit technology, what a bypass meter bar is, how a well water pump works, and how to properly install the RANGER fitting at this free e-learning platform. AYU was launched in 2017 and now houses nearly 100 product related courses that are ready to be viewed, clicked through, and read by you on either a desktop, iPad, tablet, or smartphone. Whether you're in the field or at the office, AYU is knowledge available 24/7 right at your fingertips! <https://www.aymcdonaldu.com>



Share Your Ideas with Our Innovation Team

It is no secret that A.Y. McDonald's innovation department was created to make your life easier. Allowing customers to guide our innovation strategy and the projects we tackle also allows A.Y. McDonald to contribute new solutions to the market that truly make a difference. If you have a pain point you want solved or an idea you can see come to life, share them with Kelly Breitbach, our Innovation Product Manager, by emailing innovations@aymcdonald.com. All suggestions are funneled through our process and will be reviewed, ranked, and prioritized!





Industry News

EPA Releases Financial Impact Tool for Water Utilities

Providing safe and reliable drinking water is a necessity, even during the worst of times. In response to how vigilant water utilities have worked to accommodate their communities during COVID-19, the U.S Environmental Protection Agency (EPA) has released a new tool to help utilities assess the financial impact of the pandemic on operations. <https://waterfm.com/epa-releases-financial-impact-tool-for-water-utilities/>

New Products



1 1/4" RANGER Fitting

In 2019, A.Y. McDonald introduced the innovative RANGER Fitting, which not only saves time but also reduces inventory by replacing up to 99 compression connections. Recently, the 1 1/4" size was added to the mix, thus allowing this product to be assembled onto multiple ranges of 3/4", 1", and now 1 1/4" nominal pipe diameters from CTS up to PVC. When you don't know what fitting is stocked on your shelf or don't have room to stock multiple fittings, stock just one – the RANGER! <https://aymcdonald.com/search?query=ranger-fitting>

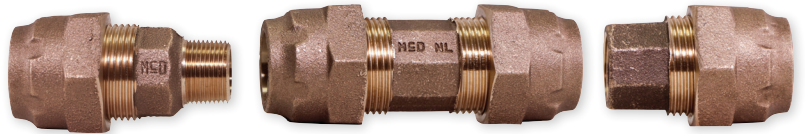

RANGER Fitting – Additional Options

Due to the success found in the A.Y. McDonald Ranger Fitting, this design can now be found in a number of water works valves. This would include curb stops (76100-11, 76104Q-11), including the innovative Repair/Cut-In Curb Stop (76100REP-11, 76104REPQ-11). With this product option, experience more versatility to the application and a leak free long-lasting connection.

<https://aymcdonald.com/search?query=76100-11>

<https://aymcdonald.com/search?query=76104Q-11>

<https://aymcdonald.com/search?query=76100REP-11>

<https://aymcdonald.com/search?query=76100REPQ-11>

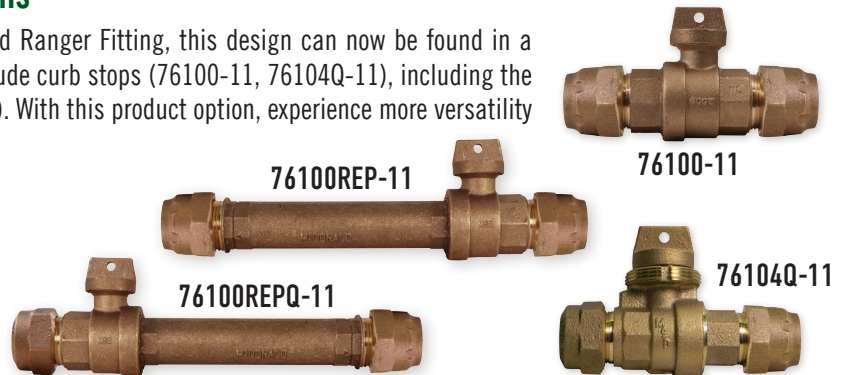

Blog

How Innovation Makes Waves in the Water Industry

The water industry has been around for well over a century. While the methods in which this resource is supplied to communities have slowly evolved, certain parts and processes have been upgraded quite a bit over time. Between mobile apps, intelligent irrigation, and water leak detection alternatives, the industry is no stranger to embracing innovative ideas. <https://aymcdonald.com/post/how-innovation-makes-waves-in-the-water-industry>





Industry News Innovations in Irrigation

In order to stretch the use of groundwater and keep it working for crops and livestock, the Irrigation Innovation Consortium was created in 2018. This group consists of 13 industry partners who are committed to bringing innovative solutions to the industry with the help of advanced automation, remote sensing, data management, and more. <https://waterwelljournal.com/innovations-in-irrigation/>



Featured Products



DuraMAC™ Vertical Multistage Variable Speed Simplex Booster System

As a new addition to the pump product line, the 1 1/2 to 3 HP Vertical Multistage Variable Simplex Booster lives up to all the hype. This pump has the capability of pumping up to 140 PSI and 40 gallons per minute. With an easy set-up installation, 1-year warranty, and stainless-steel pump and base, the 1 1/2 to 3 HP Vertical Multistage Variable Simplex Booster is the total package. <https://aymcdonald.com/search?query=VSB-Multi+Stage-iQpump+Micro&styles%5B%5D=20+GPM+%2F+103+PSI&styles%5B%5D=20+GPM+%2F+140+PSI&styles%5B%5D=40+GPM+%2F+066+PSI&styles%5B%5D=40+GPM+%2F+110+PSI&styles%5B%5D=40+GPM+%2F+122+PSI>

DuraMAC™ Vertical Multistage Variable Speed Duplex Booster System

A.Y. McDonald is all about providing options. In addition to the simplex design, the pump product line has also launched a 1 1/2 to 3 HP Vertical Multistage Variable Duplex Booster, which is capable of up pumping up to 140 PSI and 80 gallons per minute. This solution not only comes with an easy set-up installation and 1-year warranty, but it also includes a stainless-steel pump and base. <https://aymcdonald.com/search?query=VSB-Multi+Stage-iQpump+Micro&styles%5B%5D=40+GPM+%2F+103+PSI&styles%5B%5D=40+GPM+%2F+140+PSI&styles%5B%5D=80+GPM+%2F+066+PSI&styles%5B%5D=80+GPM+%2F+110+PSI&styles%5B%5D=80+GPM+%2F+122+PSI>



Blog

Selecting and Sizing Submersible Pump Cable

When it comes to installing a well water pump and all the parts it's composed of, there's little room for mistakes. One of the components that aids in the pump's performance is the submersible pump cable. Learn what factors need to be taken into consideration when selecting and sizing submersible pump cable for any application. <https://aymcdonald.com/post/selecting-and-sizing-submersible-pump-cable>

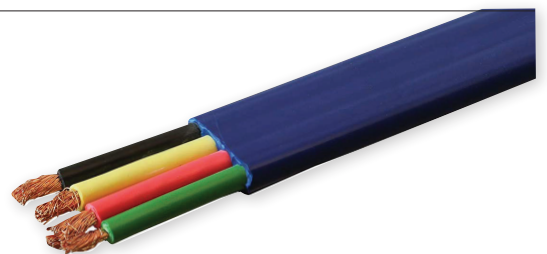



Industry News

EPA Rule to Reduce Lead Plumbing Material Finalized

In July 2020, the U.S. Environmental Protection Agency (EPA) announced a final rule to reduce lead in plumbing materials used in public water systems, homes, schools, and other facilities. Specifically, the new rule reduces the percentage of lead content allowed in these materials from 8% to 0.25% in accordance with the Reduction of Lead in the Drinking Water Act. This final rule also requires that manufacturers or importers certify that their products meet the requirements using a consistent verification process. <https://waterfm.com/epa-rule-to-reduce-lead-plumbing-materials-finalized/>



New Products

72014EXPWF No-Lead Angle Sillcock with Wide Flange

The new No-Lead Angle Sillcock with Wide Flange is ideal for applications that require the use of a quality low pressure hose valve. In addition, the wide flange allows for easier access to the mounting holes and better installation. The valve itself is made up of durable materials and parts that make for a high-quality product. <https://aymcdonald.com/search?query=72014EXPWF>

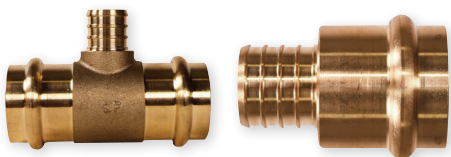
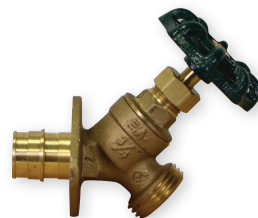

Press x PEX Adapters & Tees

A.Y. McDonald has expanded our already extensive line of No-Lead Press Fit Fittings to include Press x PEX Adapters, Press x Expansion PEX Adapters, and Press x Press x PEX Tees. By offering more options, you can further customize your order to fit the application at hand. In addition, the press fit design offers a long-lasting solution. <https://aymcdonald.com/search?query=press+fit&categories%5B%5D=Fittings&subcategories%5B%5D=Press+Fit>

Press x Rotating Flange Isolation Valve

Upgrade your inventory of Full Port Ball Valves by including A.Y. McDonald's new Press x Rotating Flange and Press x Rotating Flange with Purge Port. Both versions come with a tee handle and are used in conjunction with circulation pumps. The 360° swivel flange allows the purge port to be positioned for optimal purging convenience. Complete with a solid brass construction, this valve has a 250 cold working pressure (CWP) rating and a double o-ring, blowout-proof stem. <https://aymcdonald.com/search?query=2029P&styles%5B%5D=Press+x+Flange>

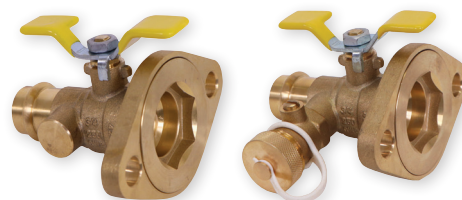

72009YS Hose Bibb Adapter

With the new 72009YS Hose Bibb Adapter, you now have the ability to run two outlets from a hose bibb/sillcock instead of one. The 72009YS has a swivel for flexibility when hooking up to your hose bibb and also comes with two shutoff points at each outlet. Have the ability to wash the car or sprinkle the lawn independently or all at once! <https://aymcdonald.com/search?query=72009YS>

Blog

How a Sillcock Can be Customized to Meet Your Needs

Although all sillcocks operate similarly, there are a number of features that set them apart, such as the handle type, turns, material, connection inlet, and mounting options. Since the application of the part serves as one of the biggest factors taken into consideration, continue reading to understand the five most common sillcock types. <https://aymcdonald.com/post/how-a-sillcock-can-be-customized-to-meet-your-needs>





Industry News

Utility Scams Are on the Rise During COVID-19

Due to the vulnerability and uncertainty that COVID-19 has brought to our society, hackers are taking advantage by impersonating utilities and targeting the consumer. This can be done by threatening to cancel service if immediate payment isn't made or requesting personal information. It's up to utilities to educate customers on the warning signs of a scam and how they should respond. <https://dailyenergyinsider.com/news/24998-utility-companies-warn-of-increasing-number-of-scams-during-covid-19-outbreak/>

New Product

Regulating Hose Kit

A.Y. McDonald's new Regulating Hose Kit is designed to provide technicians with a safe and easy way to bypass at the job site. It comes without the need for an external tank to be transported in order to perform a meter set inspection, maintenance, meter change out, regulator, riser valve, or sample testing. The kit itself is durable and lightweight and can be used with our angle body valves and inline bypass ball valves, allowing continuous service to the customer. This means no reschedules, no loss of pilot lights, and no interruption of service! <https://aymcdonald.com/post/why-ay-mcdonalds-regulating-hose-kit-is-the-whole-bypass-package>



New Product Enhancement

ArmorGalv®

Thanks to ArmorGalv® thermal-diffusion zinc coating, corrosion protection just went from better to best. A.Y. McDonald natural gas products have received an upgrade as this coating option has been added to our product line, making for an environmentally friendly and long-lasting finish.

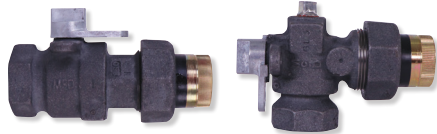

ArmorGalv® is uniformly applied on all external and internal surfaces to create a bond with the casting, truly enhancing the end result. This coating includes extensive use in marine and automotive environments, as well electrical utility applications. <https://aymcdonald.dcatalog.com/v/Natural-Gas-Catalog/?page=41>



Blog

The Top Ten Reasons Homeowners Use Natural Gas

As an energy source, natural gas is recognized as the United States' most abundant and affordable fuel, making up almost one-fourth of all the energy used nationwide. Compared to other traditional sources, such as coal or oil, it's plain to see why natural gas demand is on the rise. Learn the top ten reasons homeowners use natural gas. <https://aymcdonald.com/post/the-top-ten-reasons-homeowners-use-natural-gas>



Accessories Make Gas Meter Sets Work

Getting natural gas from underground to the meter that feeds the structure includes the assistance of many parts along the way. While most credit goes to the riser, regulator, and meter bar/valve, there are many accessories that also help with the process. <https://aymcdonald.com/post/accessories-make-gas-meter-sets-work>

